

H630B

HIGH PRODUCTION DUAL DRIVE
HORIZONTAL MACHINING CENTER

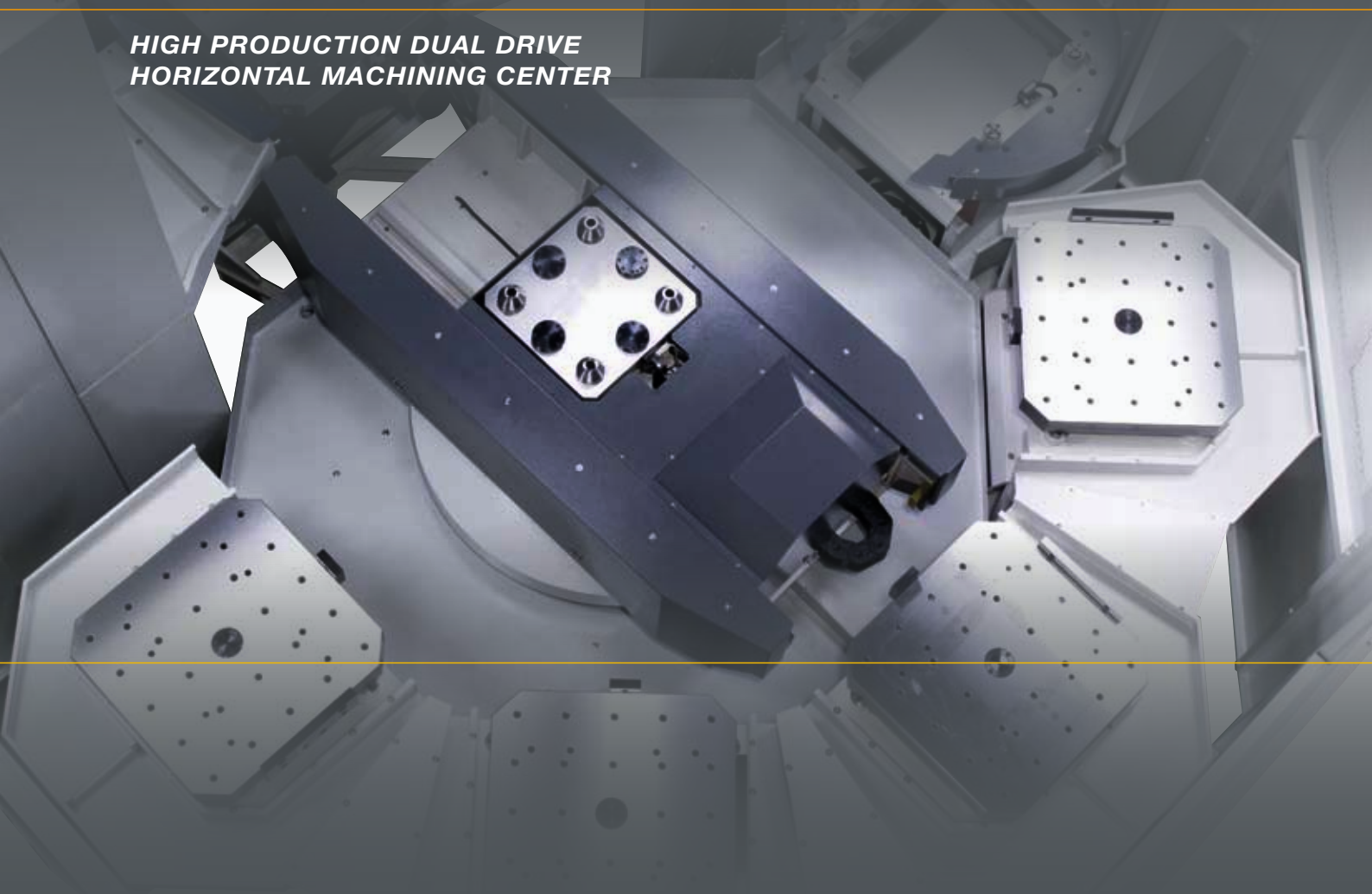

H630B

Introducing all new H630B high speed horizontal machining center. Incorporates state of the art Dual Drive technology and utmost rigid structural design to satisfy high accuracy requirement in any high production environment.





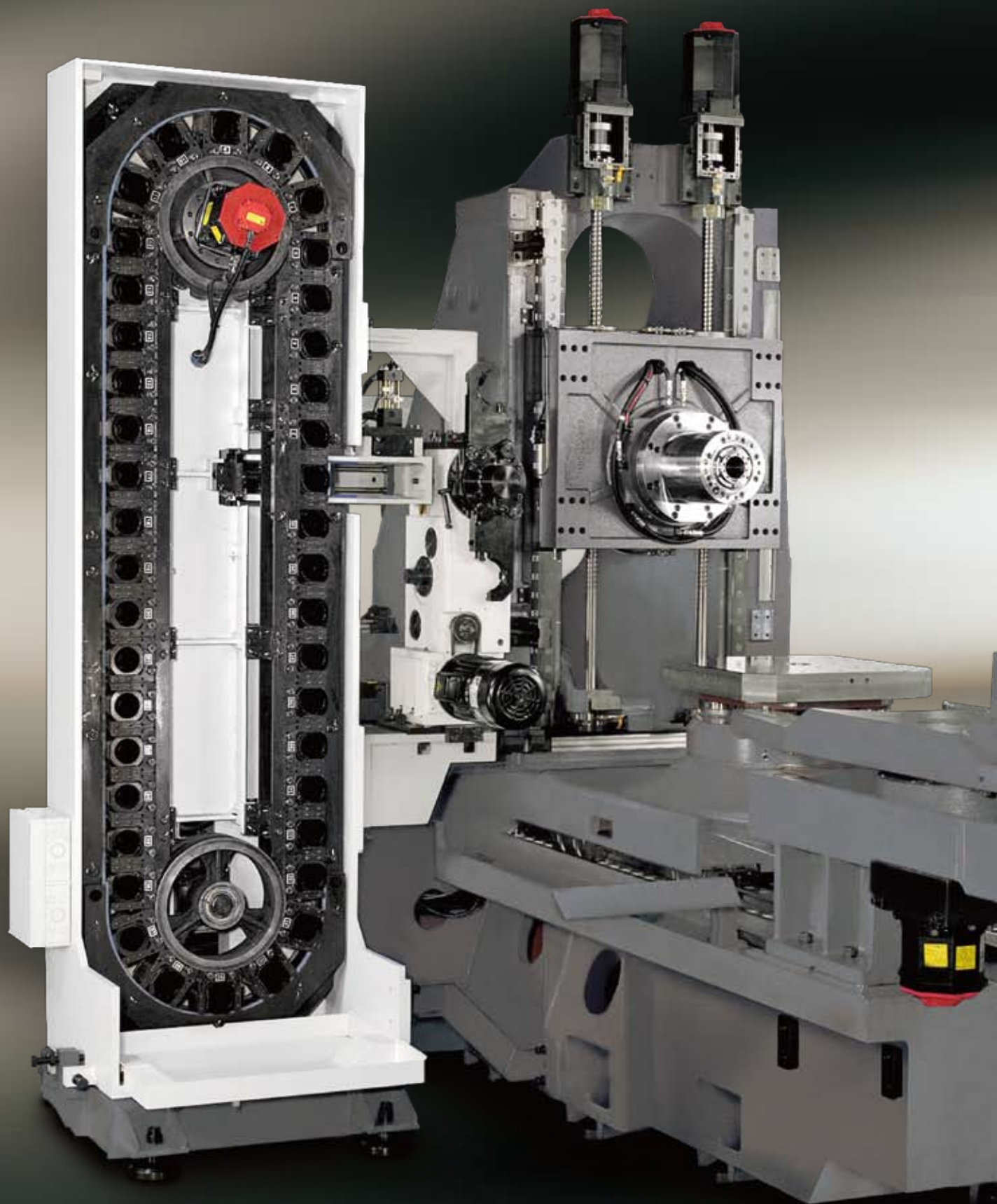



■ STEP Column Base Design



■ High Performance Pallet



■ Circulated Sleeve Cooling

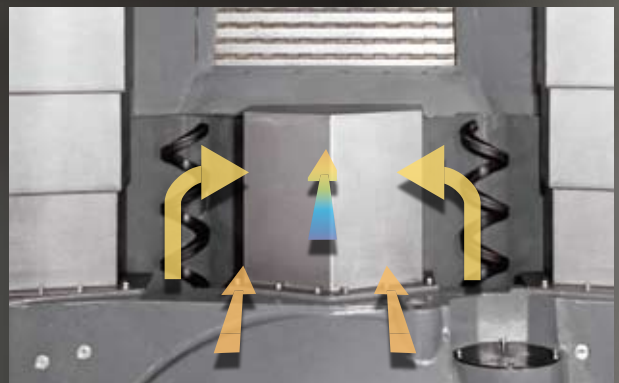

■ Central Chip Disposal



- Y-axis Dual Ballscrew Drives
- Extra Wide Z-axis Guideways
- Double Wall Design
- Symmetrical Column Design



PALLET POOL SYSTEM (OPT.)

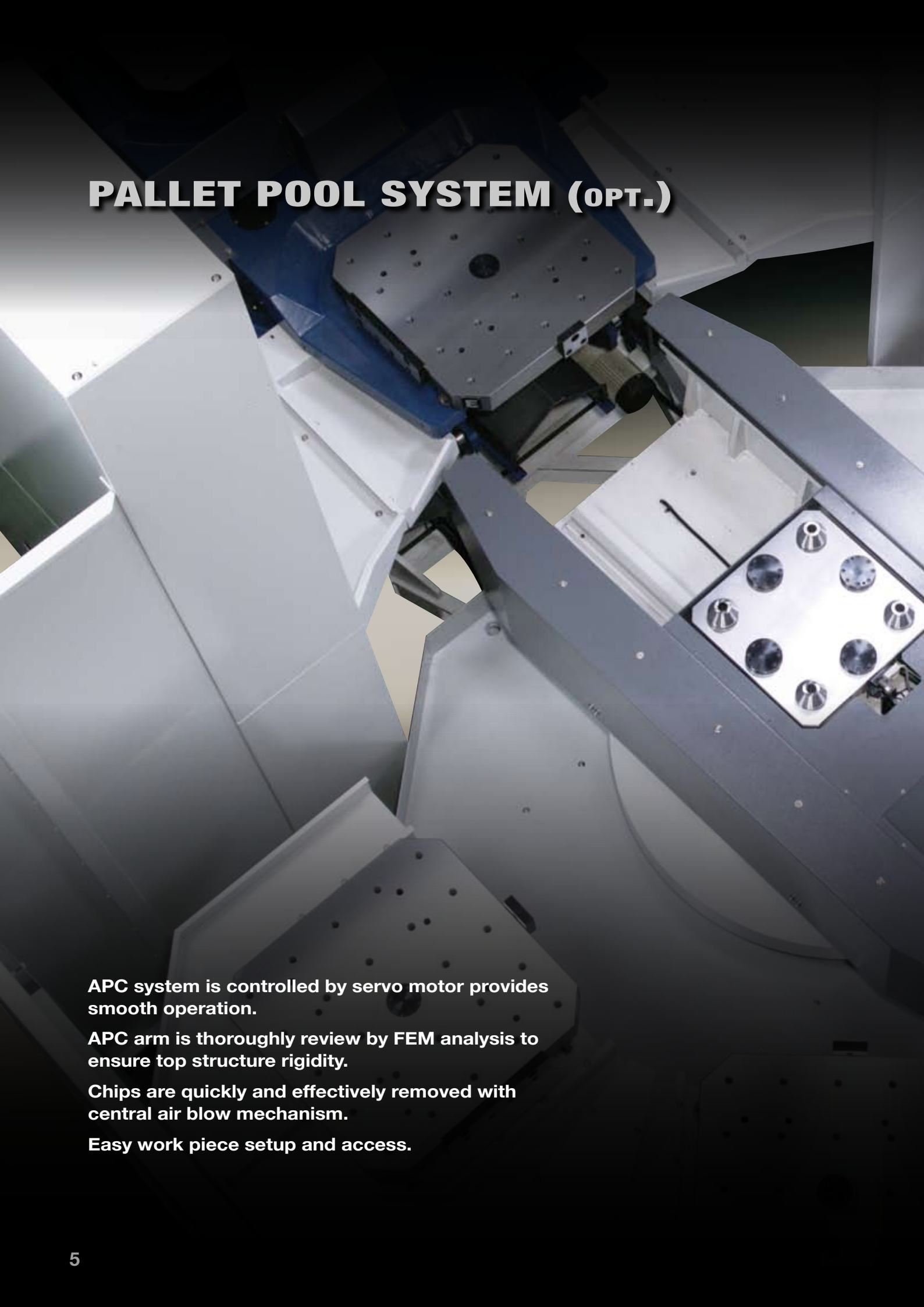

APC system is controlled by servo motor provides smooth operation.

APC arm is thoroughly review by FEM analysis to ensure top structure rigidity.

Chips are quickly and effectively removed with central air blow mechanism.

Easy work piece setup and access.

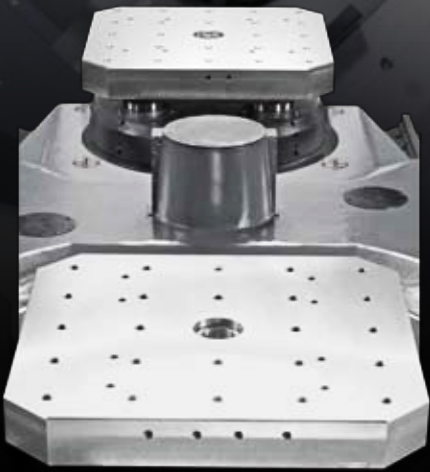

1,200kg Max. Pallet Load
ø1,050x1,000mm

**Max.
Workpiece Size**

**Large 630x630mm
Pallet Size**



INTELLIGENT SPINDLE DESIGN

The intelligent spindle incorporates temperature and vibration sensors to intelligently adjust the spindle to achieve optimal operating conditions and improve spindle accuracy dramatically.

DIMENSIONS

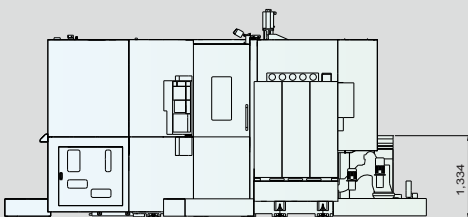
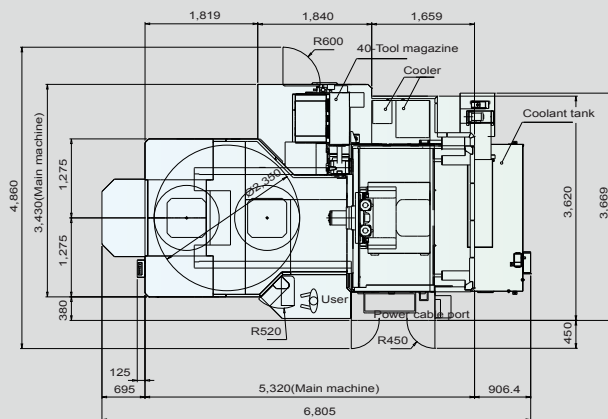

POWER CHART

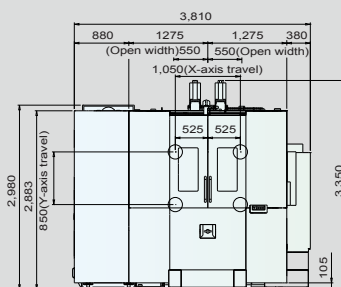
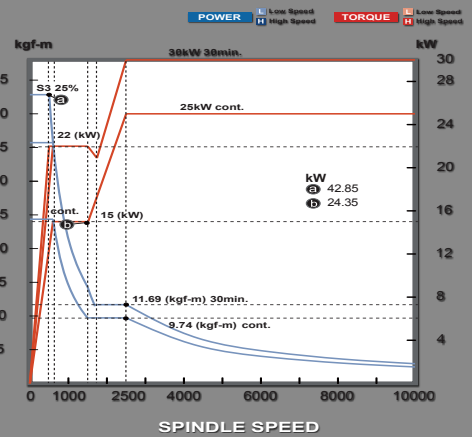

Specifications

	H630B
Spindle	
Spindle Speed	35-10,000rpm
Spindle Power	25/30kW
Spindle Taper	BBT50
Travel	
X Axis Travel	1050mm
Y Axis Travel	850mm
Z Axis Travel	850mm
Distance Between Spindle Center and Table Top	100-950mm
Distance Between Spindle Nose and Table Center	150-1,000mm
Table	
Table Size	630X630mm
Max. Load on Table	1,200kg
Max. Work Dimensions	ø1,050X1,000mm
The Height from Table Top to Floor	1,300mm
Table Index	1°(0.001°)
APC Time	12sec
Feedrate	
Rapid Feedrate (X/Y/Z)	40m/min
Cutting Feedrate	20,000mm/min
ATC	
Tool Magazine Capacity	40T(60/120T)
Max. Tool Weight	25kg
Max. Tool Dimensions	ø125X500mm
General	
Pneumatic Supplier	5kg/cm ²
Power Consumption	80kVA
Machine Weight	22,500kg

Note: The manufacturer reserves the right to modify the design, specifications, mechanisms...etc., to improve the performance of the machine without notice. All the specifications shown above are just for reference.

Accessories

■ : Standard ■ : Option

- Work Lamp
- Pilot Lamp
- Hydraulic System
- Oil Skimmer
- Full Chip Enclosure (includes Top Cover)
- Heavy Duty Pump (SPK2-15)
- Coolant Gun
- Cutting Air Blast
- Guideway Cover (X,Y,Z)
- Central Lubrication System
- Spindle Cooling System
- Rotary Table (1° Index)
- 2 Pallets
- Mechanical, Electrical & Operating Manuals
- Heat Exchanger for Electrical Cabinet
- Chip Conveyor
- Screw Type Chip Conveyor (at 2 sides of Z-axis)
- Automatic Tool Change (40T)
- Optical Scale
- Sub-Table or Auxiliary Table
- Oil-Mist Coolant System
- Oil Hole Holder Function
- Coolant Through Spindle System
- A/C. Cooler for Electrical Cabinet
- Rotary Table (0.001° Index) & Magnetic Scale
- Workpiece Measurement System
- Auto Tool Length Measurement System





MXP-200 FB/FC

YCM CONTROL

by **FANUC**

- High Performance AC Digital Servo & Spindle Drives
- Powerful Servo Motors with Super Precision Absolute Positioning Encoders
- High-Resolution 10.4" LCD Color Monitor with Dynamic Graphic Display
- Manual Guide i Conversational Function Greatly Reduces Programming and Setup Time
- Built-in AI Contour Control II and High-Speed JERK Function
- Auto Switching on/off High Speed High Accuracy Machining Control Function
- Program Management by Program Folders and File Names
- High Speed Rigid Tapping, Helical Interpolation, Custom Macro B, and Tool Path Graphics
- Large Program Capacity with 1,280 Meters of Memory
- Full Alphanumeric Keyboard Allows Easy Program Editing
- PCMCIA Slot for Easy File Transfer and Memory Expansion
- Dynamic Display Language Switching Function
- RS-232C Interface Ready for Fast Program Transfer
- Combined Uses of Many High Performance Microprocessors, High Speed Memory and the Adoption of Multi-CPU System for Super High Speed Control Processing
- Editing and Operation of a Memory Card and Data Server (Option)
- Fanuc Program Transfer Tool (Option)
- Tool Management Functions (Option)
- Power Failure Module
- Servo Guide Mate (Option)
- Learning Control for Parts Cutting and Rigid Tapping (Option)

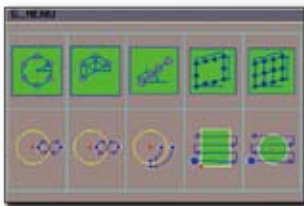

■ G-menu Function

User-friendly G-menu function provides multiple machining cycles that greatly simplifies programming steps.



■ Calculator Function

Convenient calculator function provides fast calculation and setting of work-piece offsets.



■ Easy Shop-floor Programming Manual Guide i

Easy to use conversational software offers convenience of part programming right on the shop-floor with 3-D graphical display and full simulation function.



■ Counter Function

Allows user to easily keep track on number of work pieces with:

- Main Counter
- Periodical Counter
- Daily Counter
- Over Cycle Alarm



■ Intelligent Tool Data Management

Comprehensive tool data management function allows operators to conveniently monitor and efficiently manages all position in tool magazine.

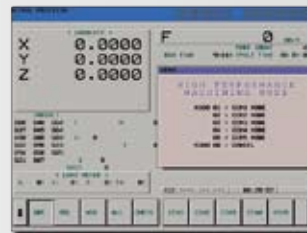

■ High Performance Machining Mode:M300

High performance mode with 5 settings that allows user to select for the best machining results.



■ Pop-up Alarm Display

Detailed troubleshooting procedures are automatically displayed when machine alarm occurs that allows users to quickly restore machine status to minimize downtime.



■ Intelligent Maintenance Reminder

Pre-set maintenance schedules are programmed to remind operators to inspect periodically and to prolong machine life.



■ Automatic Tool Length Measurement

Pre-set macros and graphical procedure are provided for operation of automatic tool length measurement function.



■ Manual Tool Length Measurement

Easy setup of tool length measurement provides convenient setting of tool offsets data from one tool to the other.

i OPERATION *Plus*

Software enhancement exclusively from YCM

Multi-function Display

Easily select multiple windows from the following list of display for your monitoring needs.

- G-modal Status ■ Feed Rate ■ Parts Count ■ Controller Running Hours
- M-code Status ■ Tool Data ■ Machining Hours ■ Spindle Load
- Spindle Status ■ Work Coordination ■ Date and Time ■ Function Display



High Speed Machining Mode:M400

Artificially intelligent machining function that is developed from accumulation of all YCM knowledge and experience on high speed to achieve the fastest cycle time with best machining results. Machining efficiency improved by +25% without sacrificing machining accuracy.

+25%

Efficiency increased by:



Wireless Message Notification (Optional)

Integrating GSM communication and CNC technology, YCM developed the WMN system for wireless notification of machine and work status report.

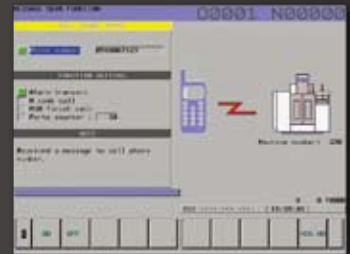

i-Direct

A remote monitoring system

i-Direct, the latest YCM software enhancement innovation for remote factory production line monitoring system. Its powerful features include complete machine operation status, record, history, and data analysis. During alarm generated events, instant messages can be sent thru email or short message to 3 sets of cellphones. All these are done remotely thru internet with our user friendly interface, truly making unman factory management at your finger tips.



User account administration



Individual machine status display



Machine model, number, email, sms and ip setup

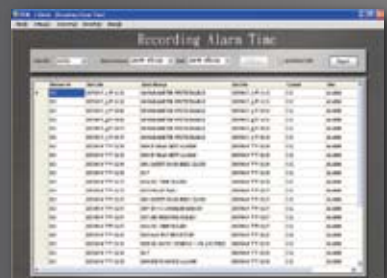

Complete production, standby, and down time record

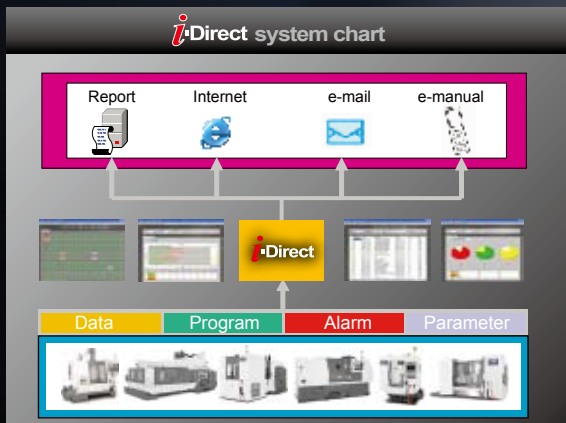

Over all machine status display



Production data graphical analysis